

# XD1225

## INSTALLATION/OWNER'S MANUAL

AM/FM/CD Receiver with Auxiliary Input, USB Charging Port and Detachable Face

COMPACT  
**disc**  
DIGITAL AUDIO

**USB**  
Charge Port

**AUX**  
Front Panel Input

**Dual**<sup>®</sup>



## Preparation

Please read entire manual before installation.

### Before You Start

- Disconnect negative battery terminal. Consult a qualified technician for instructions.
- Avoid installing the unit where it would be subject to high temperatures, such as from direct sunlight, or where it would be subject to dust, dirt or excessive vibration.

### Getting Started

- Remove 2 transit screws located on top of the unit.
- Insert the supplied keys into the slots as shown, and slide the unit out of the mounting sleeve.
- Install mounting sleeve into opening, bending tabs to secure.
- Connect wiring harness and antenna. Consult a qualified technician if you are unsure.
- Certain vehicles may require an installation kit and/or wiring harness adapter (sold separately).
- Test for correct operation and slide into mounting sleeve to secure.
- Snap trim ring into place.

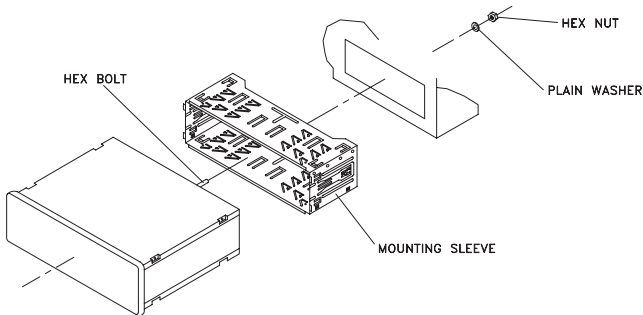
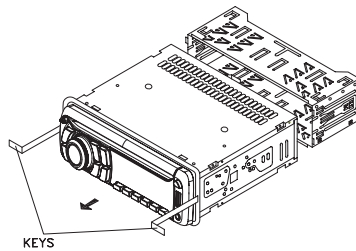

TYPICAL MOUNTING METHOD

# Wiring Diagram

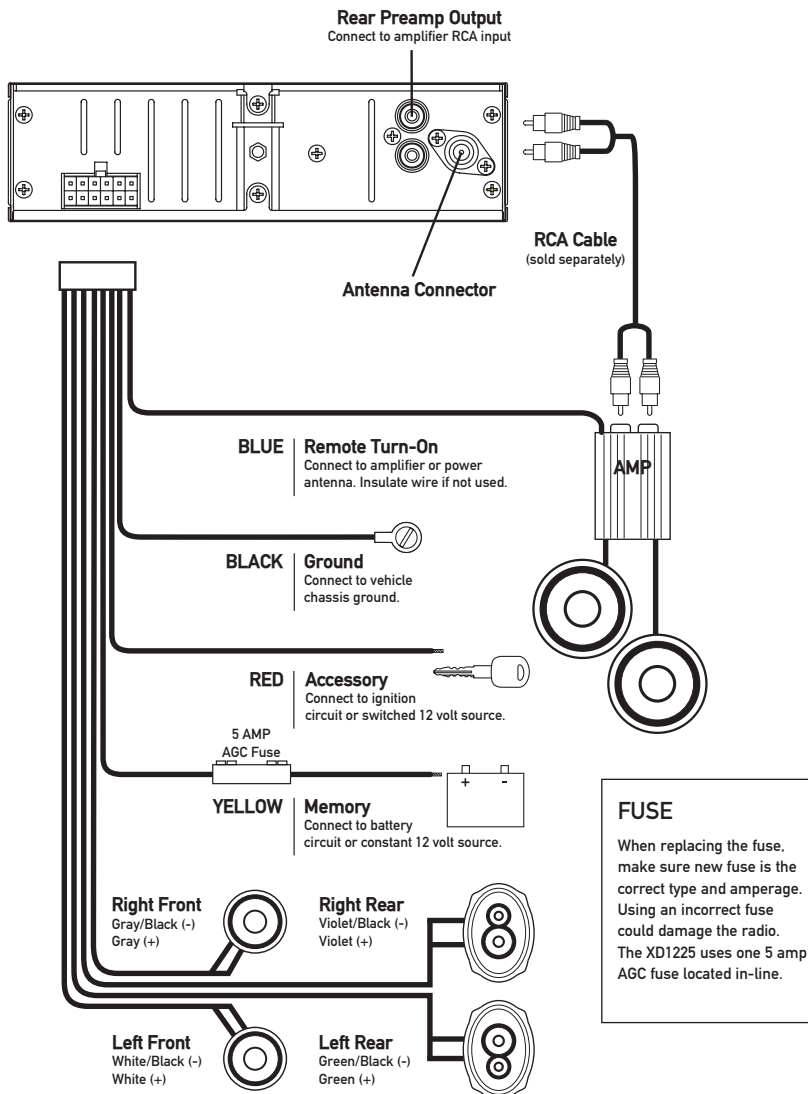

\* **Caution** - Do not attach any speaker leads to ground as severe damage will occur.





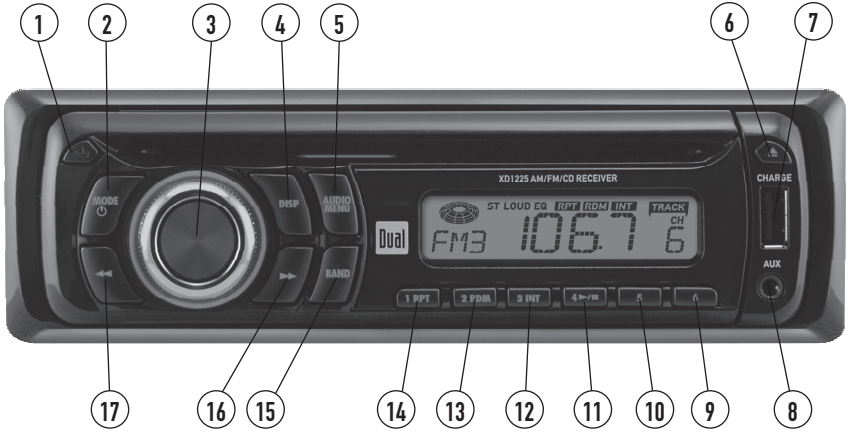

# Control Locations



- |                     |                           |
|---------------------|---------------------------|
| ① Release           | ⑩ Preset 5                |
| ② Mode / Power      | ⑪ Preset 4 / Play / Pause |
| ③ Volume Knob       | ⑫ Preset 3 / Intro        |
| ④ Display           | ⑬ Preset 2 / Random       |
| ⑤ Audio / Menu      | ⑭ Preset 1 / Repeat       |
| ⑥ Eject             | ⑮ Band                    |
| ⑦ USB Charging Port | ⑯ Tune / Track Up         |
| ⑧ Auxiliary Input   | ⑰ Tune / Track Down       |
| ⑨ Preset 6          |                           |

The XD1225 has an easy-to-use interface that provides a rewarding experience, as well as support for your favorite tunes. Audio CD-R and CD-RW disc playback ensures compatibility with your music collection, and the RCA preamp output provides the right connections to expand your system. From its front panel auxiliary input for connecting your MP3 player, to the detachable face for security assurance, this head unit has you covered.

## General Operation

<b>Faceplate Removal</b>	Press <b>RELEASE</b> and pull away from the left side to remove. To re-install, insert right side of faceplate first then push left side to secure.
<b>Semi-permanent Faceplate Installation</b>	Remove trim ring and install supplied #1 x 7/32" Phillips head screw through left side of mounting frame into faceplate.
<b>Power On/Off</b>	Press  to turn the unit on. Inserting a CD will turn the unit on automatically. Press and hold for three seconds  to turn the unit off.
<b>Mode</b>	Press <b>MODE</b> to select between AM/FM, CD or auxiliary input. Modes of operation are indicated in the display.
<b>Auxiliary Input</b>	Insert a 3.5mm connector in the front panel AUX port. Connect the other end of the 3.5mm connector to the headphone output of an audio device, MP3 player, etc. Press <b>MODE</b> to select AUX mode.
<b>Volume</b>	Adjust volume using the <b>rotary encoder</b> (00-46).
<b>Display</b>	The radio frequency (tuner mode) and CD track/elapsed time (CD player mode) will be shown by default. Press <b>DISP</b> to display the clock, and press <b>DISP</b> again to return to default display.
<b>Set the Clock</b>	Press and hold <b>DISP</b> for 2 seconds, the clock will begin to flash. Press <b>TRACK</b>  to adjust the hours and <b>TRACK</b>  to adjust the minutes. Press <b>DISP</b> or wait 5 seconds to save the clock settings.
<b>12/24-hour Clock</b>	The clock will display 12-hour AM/PM time in USA frequency spacing mode (PM 10:00). In European frequency spacing mode, the clock will display 24-hour time (22:00).
<b>Reset</b>	Press and hold for more than 2 seconds to <b>RESET</b> the unit upon initial installation. The <b>RESET</b> button is located behind the faceplate.



## General Operation

**Setup Menu** | Press and hold **AUDIO/MENU** for more than 3 seconds to access the setup menu, then press **AUDIO/MENU** to cycle through menu options. When desired option appears in the display, rotate the **volume knob** left/right to adjust or activate the desired function.

Menu Function	Options	Action
Loudness Curve	LOUD OFF	Disables the loudness function.
	LOUD ON	Enables the loudness function. Activating this feature will enhance the bass and treble frequencies when listening to music at low volumes.
Tuner Frequency Spacing	FRE USA	Programs the unit to USA tuner spacing. (200kHz for FM and 10kHz for AM). <b>(Tuner mode only)</b>
	FRE EU	Programs the unit to European tuner spacing. (50kHz for FM and 9kHz for AM). <b>(Tuner mode only)</b>
Local/Distance Tuning	LOC OFF	Activates distance tuning.
	LOC ON	Activates local tuning for strong station reception only.
Clock Display	CLOC ON	Programs unit to display the clock when the power is off.
	CLOC OFF	Programs unit to not display the clock when the power is off.
Beep Confirmation	BEEP OFF	Disables the confirmation beep.
	BEEP ON	Enables the confirmation beep.

**USB Charging Port** | Insert the USB connector of a battery powered USB device into the USB charging port on the front panel, which provides 5 volts DC and 1.0 amps. The USB device will immediately begin charging.

**Note:** The USB charging port may not be compatible with every device due to differences in power requirements.

**Note:** This USB port provides power only, and will not playback music from a USB device.

**Audio** | Press **AUDIO** to select between Volume (default), Bass, Treble, Balance, Fader and EQ.

→VOLUME →BASS→TREBLE→BALANCE→FADER→EQ

## Audio Operation

<b>Bass</b>	Press <b>AUDIO</b> until <b>BAS</b> appears Rotate the <b>volume knob</b> left/right to adjust (-6 minimum / 6 maximum)
<b>Treble</b>	Press <b>AUDIO</b> until <b>TRE</b> appears Rotate the <b>volume knob</b> left/right to adjust (-6 minimum / 6 maximum)
<b>Balance</b>	Press <b>AUDIO</b> until <b>BAL</b> appears Rotate the <b>volume knob</b> left/right to adjust (LF 12 - RT 12) "BAL L=R" represents equal balance.
<b>Fader</b>	Press <b>AUDIO</b> until <b>FAD</b> appears Rotate the <b>volume knob</b> left/right to adjust (FR 12 - RR 12) "FAD R=F" represents equal balance.
<b>Preset EQ Curves</b>	Press <b>AUDIO</b> until <b>EQ</b> appears. Rotate volume knob left/ right to adjust between <b>CLS</b> , <b>POP</b> , <b>ROC</b> and <b>OFF</b> (default) equalization curves. Any adjustment to the Bass or Treble settings automatically cancels the current EQ curve.

## Tuner Operation

<b>Seek Tuning</b>	Press <b>TUNE</b> ◀◀ or <b>TUNE</b> ▶▶ for more than 2 seconds to seek to the next strong station.
<b>Manual Tuning</b>	Press <b>TUNE</b> ◀◀ or <b>TUNE</b> ▶▶ momentarily to change the radio frequency up or down one step at a time. Press and hold to advance quickly.
<b>FM Stereo/Mono</b>	Press <b>BAND</b> for more than 2 seconds to select mono or stereo (default) reception of the broadcast signal.
<b>Band</b>	Press <b>BAND</b> to select between <b>FM1</b> , <b>FM2</b> , <b>FM3</b> and <b>AM1</b> , <b>AM2</b> bands.
<b>Storing and Recalling Station Presets</b>	Up to 18 FM stations and 12 AM stations can be stored. To store a station, select the desired band and station. Press and hold the desired preset button for more than 2 seconds. When stored, the preset number will appear in the display. The station can be recalled anytime by pressing the corresponding preset button.



## CD Player Operation

<b>Insert CD</b>	With the label facing up, insert a standard size CD into the CD slot. The CD will automatically begin playback.
<b>Eject CD</b>	Press the <b>EJECT</b> button to stop and eject the CD. The unit will change to tuner mode.
<b>Track Select</b>	Press <b>TRACK ►►</b> to skip to the beginning of the next track. Press <b>TRACK ◄◄</b> to return to the beginning of the current track. Pressing <b>TRACK ◄◄</b> again skips to the beginning of the previous track.
<b>Fast Forward and Reverse</b>	Press and hold <b>TRACK ►►</b> or <b>TRACK ◄◄</b> to fast forward or reverse a track.
<b>Pause</b>	Press <b>►/  </b> to temporarily stop CD playback. Press <b>►/  </b> again to resume playback.
<b>Intro</b>	Press <b>INT</b> to play the first 10 seconds of each track. Press <b>INT</b> to cancel.
<b>Repeat</b>	Press <b>RPT</b> to continuously repeat selected track. Press <b>RPT</b> to cancel.
<b>Random</b>	Press <b>RDM</b> to play all tracks in random order. Press <b>RDM</b> again to cancel.
<b>CD-R/CD-RW Compatibility</b>	<p>Some CD-Rs and CD-RWs may be incompatible with this unit, depending on media type and recording method.</p> <p>Note: CD-R recording sessions must be closed (finalized) for playback.</p>



## Troubleshooting

Problem	Cause	Action
Unit will not turn on (no power)	Yellow wire not connected or incorrect voltage	Check connections for proper voltage (11–16VDC)
	Red wire not connected or incorrect voltage	Check connection to ground
	Black wire not connected	Check connection to ground
Unit has power (but no sound)	Fuse blown	Replace fuse
	Speaker wires not connected	Check connections at speakers
	One or more speaker wires touching each other or touching chassis ground	Insulate all bare speaker wires from each other and chassis ground
Unit blows fuses	Yellow or red wire touching chassis ground	Check for pinched wire
	Speaker wires touching chassis ground	Check for pinched wire
	Incorrect fuse rating	Use fuse with correct rating
Excessive skipping	Unit is not mounted correctly	Check mounting sleeve or add a backstrap support
	Physical defect in media (CD, CD-R or CD-RW)	Check media for scratches
Unit will not accept a disc	CD mechanism position out of alignment	Press <b>EJECT</b> for 3 seconds to reset CD mechanism position
	CD transit screws still in place	Remove 2 transit screws located on top of the unit.

## Error Codes

Error Code	Cause	Action
ER-1 appears on display	Disc error	Press eject or RESET
ER-2 appears on display	Mechanism error or disc is in upside down	Press eject or RESET
ER-3 appears on display	Servo error	Press eject or RESET



## Limited One Year Warranty

This warranty gives you specific legal rights. You may also have other rights which vary from state to state.

Dual Electronics Corp. warrants this product to the original purchaser to be free from defects in material and workmanship for a period of one year from the date of the original purchase.

Dual Electronics Corp. agrees, at our option, during the warranty period, to repair any defect in material or workmanship or to furnish an equal new, renewed or comparable product (whichever is deemed necessary) in exchange without charges, subject to verification of the defect or malfunction and proof of the date of purchase. Subsequent replacement products are warranted for the balance of the original warranty period.

**Who is covered?** This warranty is extended to the original retail purchaser for products purchased from an authorized Dual dealer and used in the U.S.A.

**What is covered?** This warranty covers all defects in material and workmanship in this product. The following are not covered: software, installation/removal costs, damage resulting from accident, misuse, abuse, neglect, product modification, improper installation, incorrect line voltage, unauthorized repair or failure to follow instructions supplied with the product, or damage occurring during return shipment of the product. Specific license conditions and copyright notices for the software can be found via [www.dualav.com](http://www.dualav.com).

### What to do?

1. Before you call for service, check the troubleshooting guide in your owner's manual. A slight adjustment of any custom controls may save you a service call.
2. If you require service during the warranty period, you must carefully pack the product (preferably in the original package) and ship it by prepaid transportation with a copy of the original receipt from the retailer to an authorized service center.
3. Please describe your problem in writing and include your name, a return UPS shipping address (P.O. Box not acceptable), and a daytime phone number with your shipment.
4. For more information and for the location of the nearest authorized service center please contact us by one of the following methods:

- Call us toll-free at 1-866-382-5476
- E-mail us at [cs@dualav.com](mailto:cs@dualav.com)

**Exclusion of Certain Damages:** This warranty is exclusive and in lieu of any and all other warranties, expressed or implied, including without limitation the implied warranties of merchantability and fitness for a particular purpose and any obligation, liability, right, claim or remedy in contract or tort, whether or not arising from the company's negligence, actual or imputed. No person or representative is authorized to assume for the company any other liability in connection with the sale of this product. In no event shall the company be liable for indirect, incidental or consequential damages.



---

## FCC Compliance

This device complies with Part 15 of the FCC Rules. Operation is subject to the following two conditions:

- (1) this device may not cause harmful interference, and
- (2) this device must accept any interference received, including interference that may cause undesired operation.

**Warning:** Changes or modifications to this unit not expressly approved by the party responsible for compliance could void the user's authority to operate the equipment.

**Note:** This equipment has been tested and found to comply with the limits for a Class B digital device, pursuant to Part 15 of the FCC Rules. These limits are designed to provide reasonable protection against harmful interference in a residential installation. This equipment generates, uses and can radiate radio frequency energy and, if not installed and used in accordance with the instructions, may cause harmful interference to radio communications. However, there is no guarantee that interference will not occur in a particular installation. If this equipment does cause harmful interference to radio or television reception, which can be determined by turning the equipment off and on, the user is encouraged to try to correct the interference by one or more of the following measures:

- Reorient or relocate the receiving antenna.
- Increase the separation between the equipment and receiver.
- Connect the equipment into an outlet on a circuit different from that to which the receiver is connected.
- Consult the dealer or an experienced radio/TV technician for help.

# Specifications

CD Player	Frequency response: <b>20Hz-20kHz</b> Channel separation @ 1kHz: <b>&gt;65dB</b> D/A converter: <b>1 Bit</b>
FM Tuner	Tuning range: <b>87.5MHz-107.9MHz</b> Usable sensitivity: <b>12dBf</b> 50dB quieting sensitivity: <b>16dBf</b> Stereo separation @ 1kHz: <b>40dB</b> Frequency response: <b>30Hz-13kHz</b>
AM Tuner	Tuning range: <b>530kHz-1710kHz</b> Usable sensitivity: <b>30uV</b> Frequency response: <b>80Hz-2kHz</b>
General	Speaker output impedance: <b>4-8 ohms</b> Fuse: <b>5 amp AGC</b> Dimensions: <b>7" x 7" x 2" (178 x 178 x 51 mm)</b>  Design and specifications subject to change without notice.



## CEA-2006 Power Standard Specifications

(reference: 14.4VDC +/- 0.2V, 20Hz~20kHz)

Power Output: 5 Watts RMS x 4 channels at 4 ohms and  $\leq 1\%$  THD+N  
Signal to noise ratio: 75dB (reference: 1 watt into 4 ohms)



Dual Electronics Corp.  
Toll Free: 1-866-382-5476